

Three Electrode Gas Tube Surge Arrester

Part Number: **3P-1L1**

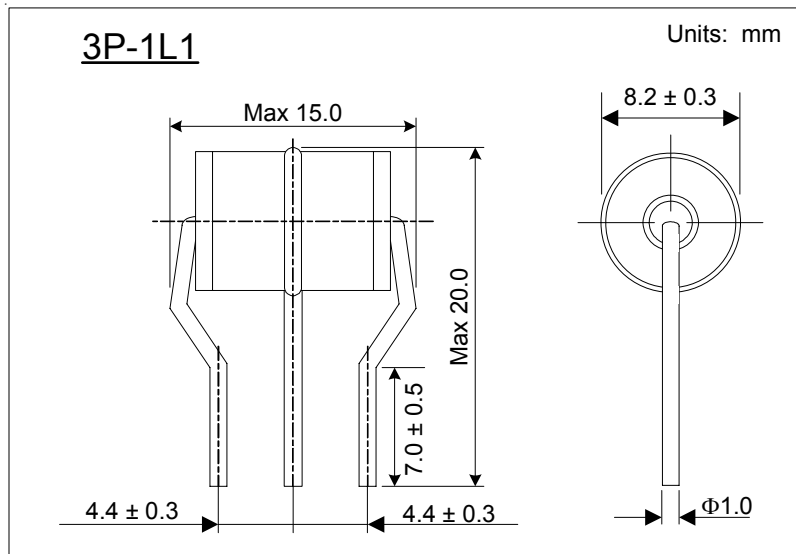

Features:

- UL 497B Recognized
- File E140906
- Non-Radioactive
- Durable Construction
- Low Capacitance
- ISO 9001 Certified

Applications:

- Transient Voltage Surge Suppression
- Telephone Network Interfaces
- Modems/Cable Modems
- xDSL Modems and Peripherals
- Building Entry/Outside Plant

Marking Example Part Number 3P-1L1

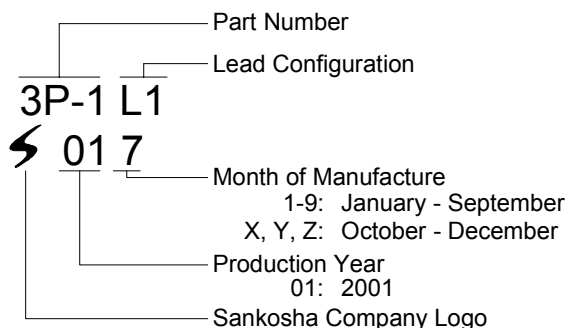

Electrical Characteristics

1.	DC Breakdown Voltage	100 V/sec	90V ± 20%	(L1-E) (L2-E)		
2.	Impulse Breakdown Voltage	100 V/μsec	< 600 V	(L1-E) (L2-E)		
		1 kV/μsec	< 1050 V	(L1-E) (L2-E)		
3.	Insulation Resistance	DC 50 V	> 10,000 M-ohm			
4.	Capacitance	1 MHz	< 2.0 pF			
5.	DC Holdover Voltage	See Note	< 60V	Note: 10/1000 μsec, 500A per REA		
6.	Impulse Life	10/1000 μsec	500 A	500 Times	(L1+L2-E)	
7.	Impulse Discharge Current	8/20 μsec	20 kA	1 Time	(L1+L2-E)	
		8/20 μsec	10 kA	Each Polarity 5 Times	(L1+L2-E)	
8.	AC Discharge Current	60 Hz	180 A	11 cycles	1 Time	(L1+L2-E)
		60 Hz	24 A	One Second	10 Times	(L1+L2-E)

After Life Tests

9.	DC Breakdown Voltage	100 V/sec	90V ± 50%			
10.	Impulse Breakdown Voltage	100 V/μsec	< 900 V			
11.	Insulation Resistance	DC 50 V	> 1 M-ohm			

SANKOSHA

SANKOSHA