

Three Electrode Gas Tube Surge Arrester

Part Number: 3YVJ-200J1

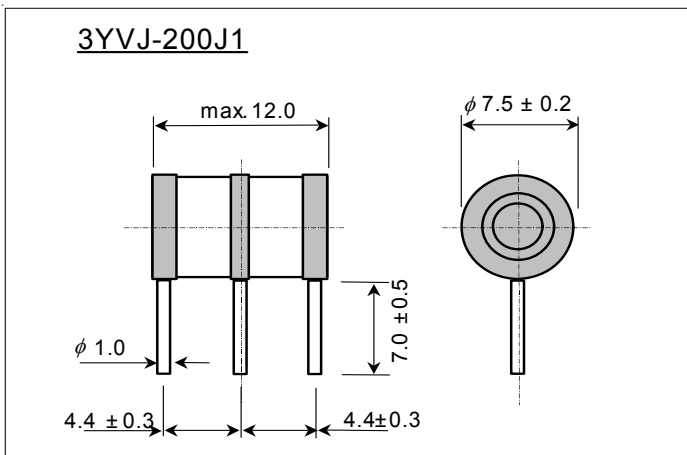

Applications:

- Transient Voltage Surge Suppression
- Telephone Network Interfaces
- Modems/Cable Modems
- xDSL Modems and Peripherals
- Building Entry/Outside Plant

Features:

- Non-Radioactive
- 100% Lead Free (RoHS Compliant)
- Durable Construction
- Low Capacitance
- ISO 9001 Certified
- World Renowned Quality

Marking

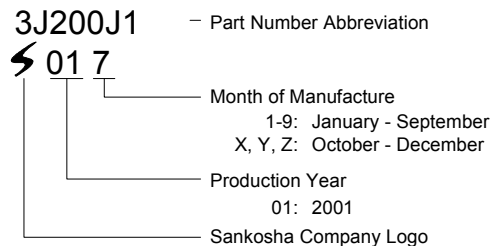

Electrical Characteristics

1.	DC Breakdown Voltage	100 V/sec	200V ± 25%	(L1-E) (L2-E)		
2.	Impulse Breakdown Voltage	100 V/μsec	< 500 V	(L1-E) (L2-E)		
		1 kV/μsec	< 650 V	(L1-E) (L2-E)		
3.	Insulation Resistance	DC 100 V	> 10,000 M-ohm			
4.	Capacitance	1 MHz	< 3.0 pF			
5.	DC Holdover Voltage	See Note	< 135V	Note: ITU-T K.12 or IEEE C62.31-1987 Test Circuit		
6.	Impulse Life	10/1000 μsec	400 A	300 Times	(L1+L2-E)	
7.	Impulse Discharge Current	8/20 μsec	20 kA	1 Time	(L1+L2-E)	
		8/20 μsec	10 kA	Each Polarity 5 Times	(L1+L2-E)	
8.	AC Discharge Current	50 Hz	130 A	9 cycles	1 Time	(L1+L2-E)
		50 Hz	10 A	One Second	10 Times	(L1+L2-E)

After Life Tests

9.	DC Breakdown Voltage	100 V/sec	200V ± 50%			
10.	Impulse Breakdown Voltage	100 V/μsec	< 900 V			
11.	Insulation Resistance	DC 100 V	> 1 M-ohm			

SANKOSHA

SANKOSHA